

Original T-A Drill Inserts

1 Series | Carbide | Diameter Range: 0.690" - 0.960" (17.53mm - 24.38mm)

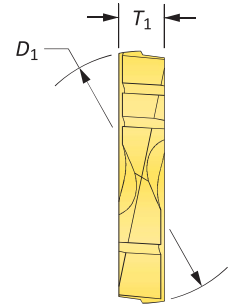

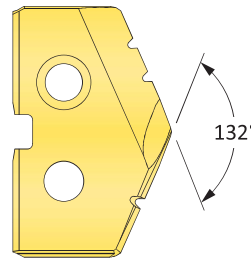

Standard

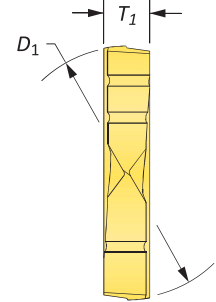
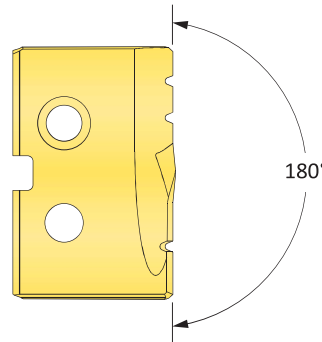

Flat Bottom



Carbide Inserts – C2 (K20)

Series	Fractional Equivalent	Insert			Part No.		Flat Bottom Part No.
		D ₁ inch	D ₁ mm	T ₁	 TiN	 TiAlN	 TiN
1	45/64	0.7031	17.86	5/32	1C21T-.703	1C21A-.703	1C21T-.703-FB
	-	0.7087	18.00	5/32	1C21T-18	1C21A-18	1C21T-18-FB
	23/32	0.7188	18.26	5/32	1C21T-0023	1C21A-0023	1C21T-0023-FB
	-	0.7283	18.50	5/32	1C21T-18.5	1C21A-18.5	1C21T-18.5-FB
	47/64	0.7344	18.65	5/32	1C21T-.734	1C21A-.734	1C21T-.734-FB
	-	0.7480	19.00	5/32	1C21T-19	1C21A-19	1C21T-19-FB
	3/4	0.7500	19.05	5/32	1C21T-0024	1C21A-0024	1C21T-0024-FB
	49/64	0.7656	19.45	5/32	1C21T-.765	1C21A-.765	1C21T-.765-FB
	-	0.7677	19.50	5/32	1C21T-19.5	1C21A-19.5	1C21T-19.5-FB
	25/32	0.7813	19.84	5/32	1C21T-0025	1C21A-0025	1C21T-0025-FB
	-	0.7874	20.00	5/32	1C21T-20	1C21A-20	1C21T-20-FB
	51/64	0.7969	20.24	5/32	1C21T-.796	1C21A-.796	1C21T-.796-FB
	-	0.8010	20.34	5/32	1C21T-.801	1C21A-.801	1C21T-.801-FB
	-	0.8071	20.50	5/32	1C21T-20.5	1C21A-20.5	1C21T-20.5-FB
	13/16	0.8125	20.64	5/32	1C21T-0026	1C21A-0026	1C21T-0026-FB
	-	0.8268	21.00	5/32	1C21T-21	1C21A-21	1C21T-21-FB
27/32	0.8438	21.43	5/32	1C21T-0027	1C21A-0027	1C21T-0027-FB	
-	0.8465	21.50	5/32	1C21T-21.5	1C21A-21.5	1C21T-21.5-FB	
1.5	55/64	0.8594	21.83	5/32	1C21T-.859	1C21A-.859	1C21T-.859-FB
	-	0.8661	22.00	5/32	1C21T-22	1C21A-22	1C21T-22-FB
	7/8	0.8750	22.23	5/32	1C21T-0028	1C21A-0028	1C21T-0028-FB
	-	0.8858	22.50	5/32	1C21T-22.5	1C21A-22.5	1C21T-22.5-FB
	57/64	0.8906	20.62	5/32	1C21T-.890	1C21A-.890	1C21T-.890-FB
	-	0.9055	23.00	5/32	1C21T-23	1C21A-23	1C21T-23-FB
	29/32	0.9063	23.02	5/32	1C21T-0029	1C21A-0029	1C21T-0029-FB
	59/64	0.9219	23.42	5/32	1C21T-.921	1C21A-.921	1C21T-.921-FB
	-	0.9252	23.50	5/32	1C21T-23.5	1C21A-23.5	1C21T-23.5-FB
	15/16	0.9375	23.81	5/32	1C21T-0030	1C21A-0030	1C21T-0030-FB
-	0.9449	24.00	5/32	1C21T-24	1C21A-24	1C21T-24-FB	

NOTE: 1.5 series inserts fit into both 1 and 1.5 series holders. However, 1 series inserts ONLY fit into 1 series holders. See page A30: 7 for visual.

A30: 112 - 143

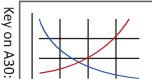

Key on A30: 1

A30: 52 - 56



A30: 4 - 6



HI, HR, CR, TC, SK, NP, IN, RN, CN, AN, BR, CI, CP, NC, WC

A30: 4 - 6



FN

Coatings not listed above can be supplied as non-stocked standards. Process fees apply. →

TiN = 1C21T-XXXX	TiAlN = 1C21A-XXXX
TiCN = 1C21N-XXXX	AM200® = 1C21H-XXXX

Inserts sold in quantities of 1